

Magnetic bearing electronics

# MBC1400

BG13000-xxNx

Translation of the original instructions

MECOS AG  
Hardstrasse 319  
CH-8005 Zürich

Tel. +41 (0)52 355 52 11  
Fax. +41 (0)52 355 52 24

[mecos@mecos.com](mailto:mecos@mecos.com)  
[www.mecos.com](http://www.mecos.com)

© 2020  
BG13501-01NB V1.04



# Instruction manual





**EC Declaration of Conformity**

**Manufacturer:** MECOS AG  
**Address:** Hardstrasse 319, 8005 Zürich, Switzerland

Name of the person who is authorized to compile the technical documentation:

**Name:** Reto Ilg  
**Function:** Development Engineer

**Equipment Type:** Magnetic Bearing Control Unit  
**Type:** MBC1400  
**Brand:** MECOS **Art. No:** BG13000-xxN

The CE mark was first applied in 2017.

Herewith we declare that the above-mentioned equipment is compliant with all relevant requirements of the following EU Directives:

- Low voltage directive 2014/35/EU
- EMC directive 2014/30/EU
- ROHS Directive 2011/65/EU

Furthermore we declare that the following standards (or parts or clauses thereof) have been applied:

IEC 61010-1:2017	Safety requirements for electrical equipment for measurement, control and laboratory use - Part 1: General requirements
EN 60204-1:2006	Safety of machinery - Electrical equipment of machines - Part 1: General requirements
EN 61000-6-4: 2007 + A1:2011	Electromagnetic compatibility (EMC) - Part 6: Generic standards - Section 4: Emission standard for industrial environments
EN 61000-6-2:2005	Electromagnetic compatibility (EMC) - Part 6: Generic standards - Section 2: Immunity for industrial environments

This product may be used exclusively in a switch cabinet or a similar appliance. Operating this product is not allowed as long as the necessary protective measures for the entire system cannot be guaranteed, and as long as the whole system is not in conformity with the provisions of the Low Voltage Directive.

The relevant technical documentation in accordance with the above mentioned EU Directive(s) has been compiled. In response to a justified request, the documentation can be transmitted in digital format to the responsible market surveillance authorities of one of the Member States.

This declaration relates exclusively only to the product in the condition in which it was placed on the market, and explicitly excludes components added and/or operations carried out subsequently by the final user. The declaration will become invalid if the product is modified without the consent of MECOS AG.

Winterthur, 3. October 2018

  
Stefan Jung  
Director Electronics

  
Markus Bosshard  
Director System Integration

## Contents

<b>1</b>	<b>General</b> .....	<b>1</b>
1.1	Equipment description .....	1
1.1.1	EC Directives .....	1
1.2	Information about this instruction manual .....	2
1.2.1	Location and reading obligations .....	2
1.3	Intellectual property rights .....	2
1.4	Manufacturer, Service address .....	2
1.5	Access assistance and conventions .....	3
1.5.1	Safety instructions .....	3
1.5.2	Pictograms .....	3
<b>2</b>	<b>Safety</b> .....	<b>4</b>
2.1	Safety concept .....	4
2.1.1	Intended use .....	4
2.1.2	Safety instructions for transport .....	5
2.1.3	Safety instructions for operation .....	5
2.1.4	Safety instructions for repairs/service/maintenance .....	6
2.1.5	Residual hazards .....	6
2.1.6	Safety instructions for the operator .....	6
2.2	Noise .....	6
2.3	Electrical power .....	7
2.4	Safety devices .....	7
2.5	Safety instructions on the device .....	7
2.5.1	Minimum discharge period after the supply has been turned Off .....	7
2.5.2	Hot surfaces .....	7
2.6	Duty cycle .....	7
<b>3</b>	<b>Hardware configurations</b> .....	<b>8</b>
3.1	Cooling plate .....	8
3.2	Sensor connections .....	8
3.3	Magnetic bearing connection .....	8
3.4	External pulse .....	9
3.5	Expansion module for measuring temperature .....	9
3.6	Ethernet / fieldbus interface .....	9
<b>4</b>	<b>Specifications</b> .....	<b>10</b>
4.1	Ambient conditions .....	10
4.2	General data .....	10

4.3	Integrated power supply .....	10
4.4	Motherboard and position sensors .....	11
4.5	Power amplifier .....	11
4.6	Communication interfaces.....	11
4.7	Expansion module.....	13
<b>5</b>	<b>Operation.....</b>	<b>16</b>
5.1	General .....	16
5.1.1	Status indicators .....	16
5.2	Boot button.....	17
5.3	Operation via the digital I/O interface .....	18
5.4	Operation via the PC interface (optional) .....	18
5.5	Calibrating the communication interfaces.....	19
5.5.1	Digital I/O configuration.....	19
5.5.2	Monitoring parameters .....	19
5.5.3	Anybus variables.....	19
5.6	Additional operating instructions .....	19
<b>6</b>	<b>Assembly and installation .....</b>	<b>20</b>
6.1	Assembly view .....	20
6.2	Electrical connections.....	22
6.3	Protective GND connections (housing) .....	36
6.4	Ventilation .....	37
6.5	EMC regulations.....	37
6.6	Additional instructions .....	37
<b>7</b>	<b>Cleaning and maintenance .....</b>	<b>38</b>
<b>8</b>	<b>Disposal and recycling .....</b>	<b>38</b>
<b>9</b>	<b>Transport.....</b>	<b>38</b>
<b>10</b>	<b>Malfunctions .....</b>	<b>39</b>
10.1	Overload.....	40
<b>11</b>	<b>Accessories .....</b>	<b>41</b>
11.1	SMX8 sensor amplifier box .....	41
11.2	UPS.....	42
11.3	Toolbox for MECOS magnetic bearing systems.....	42
<b>12</b>	<b>Warranty.....</b>	<b>43</b>
<b>13</b>	<b>Applicable documents .....</b>	<b>43</b>
<b>14</b>	<b>Notes .....</b>	<b>44</b>
<b>15</b>	<b>Glossary .....</b>	<b>45</b>

# 1 General

## 1.1 Equipment description

The magnetic bearing electronics MBC1400 is a device for active magnetic levitation of rotor systems along five axes. It consists of a universal power supply, an amplifier module with output filter and a processor board with integrated sensor electronics and I/O interfaces.

The power amplifiers have a great bandwidth allowing swift correction of any position deviations of the levitating rotor. Control is performed by a multi-processor system that simultaneously performs various control and monitoring functions. Real-time measuring of the rotor position allows actively influencing various effects of rotor dynamics; e.g., the control system can actively compensate for imbalance.

Basic operation is performed via the digital I/O interface. It allows performing elementary functions, such as lifting and lowering the rotor. For more advanced operation, such as reading errors, either the optional fieldbus interface or the Toolbox mentioned below can be used.

The integrated Ethernet interface allows communication with a PC. Using the optionally available MATLAB Toolbox for MECOS magnetic bearing systems (MecosTools), a large number of system parameters can be modified. Besides, real-time measurements of all processor variables can be performed.

The magnetic bearing electronics MBC1400 is usually supplied with power via UPS-supported grid voltage. The integrated power supply of the magnetic bearing electronics MBC1400 has a large input voltage range and can, alternatively, also be operated using DC voltage.

The specifications of the magnetic bearing electronics MBC1400 are described in Chapter 4.

A glossary explaining the most frequently used acronyms can be found at the end of these instructions.

### 1.1.1 EC Directives

A magnetic bearing electronics is a component destined for installation in stationary electrical systems or machinery. Operation (i.e., starting the intended operation) is only allowed as long as the EMC Directive is complied with.

The MBC1400 conforms with the following EC Directives:



- Low Voltage Directive
- EMC Directive (only if the corresponding installation regulations are complied with).



*The EMC regulations for installation are listed in Chapter 6.5.*

## 1.2 Information about this instruction manual

This instruction manual is an essential aid for operating the magnetic bearing electronics MBC1400 safely and successfully. It includes important instructions for operating the electronics safely, competently, and economically. Compliance with these instructions will help avoid hazards, minimize repair costs and downtimes, and increase the reliability and service life of the electronics.

### 1.2.1 Location and reading obligations

Keep the current version of the instruction manual at hand in the immediate vicinity of the magnetic bearing electronics so that it can be accessed at any time. This applies to the entire service life of the magnetic bearing electronics.

The magnetic bearing electronics operator must ensure that all persons working with the device know and comply with the contents of the instruction manual.

If you receive a revision of the instruction manual from MECOS AG, perform any work according to this revision notification.

## 1.3 Intellectual property rights

MECOS AG reserves all property rights in these instructions. Please comply with the following rules:

- Only generate reproductions of any kind and for any use, including excerpts, with the consent of MECOS AG.
- Prevent third parties from accessing the instruction manual. This shall also apply to excerpts and reproductions of any kind.
- Notify MECOS AG if you hand the magnetic bearing electronics over to another owner, and pass these instructions on to the new owner.

MECOS AG reserves initiating legal steps in case of non-compliance.

## 1.4 Manufacturer, Service address

Manufacturer:	MECOS AG	
	Hardstrasse 319	Tel. +41 (0)52 355 52 11
	CH-8005 Zürich	Fax +41 (0)52 355 52 24
	www.mecos.com	mecos@mecos.com
Service:	MECOS AG	aftersales@mecos.com

## 1.5 Access assistance and conventions

For the structural elements in this instruction manual, a distinction is made between safety instructions and pictograms.

### 1.5.1 Safety instructions

These signal words are associated with different hazard levels:



#### **DANGER!**

The signal word **DANGER!** marks an immediate, high-risk hazard that will result in severe or fatal bodily injuries if you do not avoid the situation.

**DANGER!** is used to direct attention to an immediate hazard.



#### **WARNING!**

The signal word **WARNING!** marks a potential, medium-risk hazard that might result in severe or fatal bodily injuries if you do not avoid the situation.

**WARNING!** is used to direct attention to a risk.



#### **CAUTION!**

The signal word **CAUTION!** marks a low-risk hazard that might result in minor or moderate bodily injury if you do not avoid the situation.

**CAUTION!** is used to direct attention to a risk or an unsafe procedure.

#### **NOTICE!**

The signal word **NOTICE!** marks a hazardous situation that may result in property damage if you do not avoid the situation.

### 1.5.2 Pictograms

The following pictograms are used to highlight instructions and factual information:



*Important note for fault-free function.*



*Useful hint or factual information.*



## 2 Safety

This chapter is directed at all of the users of the magnetic bearing electronics. It includes information about the safety concept and provides the minimum requirements for the safe use of the magnetic bearing electronics.



*Instructions regarding the connections can be found in Chapter 6.2.*

### 2.1 Safety concept

The magnetic bearing electronics has generally been engineered and manufactured according to the state of the art and the recognized rules of safety technology. And yet, during operation, hazards for persons and/or damage to the electronics and other assets may result if:

- The specifications for authorizing persons are not complied with (cf. Chapter 2.1.3);
- The electronics are not operated according to their intended use (cf. Chapter 2.1.1);
- The electronics are transported, installed, or maintained improperly (cf. Chapters 2.1.2, 2.1.4, and 6)

#### 2.1.1 Intended use

The magnetic bearing electronics MBC1400 are exclusively intended to be used for controlling active magnetic bearing systems from MECOS AG. They may only be used in the commercial sector. For other purposes or applications, written authorization from MECOS AG will be required.

The following operating options exist:

- Five-axis active magnetic levitation of a rotor system;
- Lifting and lowering of the rotor equipped with magnetic bearings (turning the magnetic bearings on/off) by means of an external signal or the optional fieldbus interface;
- Switching between several pre-set controller parameter sets (only if these parameter sets have been implemented);
- Communicating with an external control unit by means of a configurable interface;
- Performing measurements using MATLAB Toolbox for MECOS magnetic bearing systems (optional);
- Modifying control and other system parameters using the MATLAB Toolbox for MECOS magnetic bearing systems (optional).

The intended use of the magnetic bearing electronics shall additionally include the compliance with the precautionary measures, as well as with the operating and service instructions specified in this instruction manual.

This device is intended for use in clean and dry environments that conform with contamination level II and overvoltage category II (cf. Chapter 4.2).

Any other use, or any use beyond this, shall be considered "not the intended use". For damage resulting from such use, the user/operator of the magnetic bearing electronics shall exclusively be liable. This shall also apply to unauthorized modifications of the electronics.

## 2.1.2 Safety instructions for transport

### NOTICE!

Detailed instructions regarding transport can be found in Chapter 9.

The magnetic bearing electronics must be packed and transported by qualified, skilled personnel. Here, attention must be paid, in particular, to the weight and the hazards resulting from it.



### WARNING!

Failure of the transport equipment or improper handling can result in a corresponding hazard to health. The national and local regulations for handling heavy loads must be complied with. Suitable and tested lifting and lashing gear must exclusively be used.

## 2.1.3 Safety instructions for operation

The operator must have clearly specified the responsibility for the different activities in the context of operation, and the personnel assigned in this manner must comply with these specifications.

The magnetic bearing electronics may only be used in a technologically fault-free condition, and for its intended use, in a safety- and hazard-conscious manner, and while complying with this instruction manual! In particular, malfunctions that can affect safety must be promptly eliminated.

Work on the electrical system (cabinet wiring, magnetic bearing electronics and magnetic bearing components) may only be performed by qualified, skilled electricians. The international, national, and local regulations must be taken into account.



### WARNING!

The MBC1400 is operated with a hazardous voltage. During operation, the device must not be opened, and cables must not be plugged in or unplugged. There is a risk of fatal electrocution, and of unintended dropping of the machine's rotor.

### 2.1.4 Safety instructions for repairs/service/maintenance

Repairs of the magnetic bearing electronics shall exclusively be performed by MECOS. The device must not be opened.



#### **WARNING!**

The MBC1400 is operated with a hazardous voltage. During operation, the device must not be opened, and cables must not be plugged in or unplugged. There is a risk of fatal electrocution, and of unintended dropping of the machine's rotor.



#### **WARNING!**

The MBC1400 contains components for storing electrical energy. Unauthorized opening of the device, as well as improper interventions may result in bodily injury and property damage. The device must not be opened.

### 2.1.5 Residual hazards

Even if all safety provisions are complied with, there will be certain residual hazards when handling the magnetic bearing electronics.

All persons working on and with the magnetic bearing electronics must know these hazards, and comply with the safety instructions in this instruction manual and/or on the magnetic bearing electronics.

### 2.1.6 Safety instructions for the operator

The operator must organize personnel responsibilities according to the specifications of this instruction manual. In doing so, the different requirements during the device's lifecycle (transport, installation, commissioning, operation, troubleshooting, service) must be taken into account, and personnel with the corresponding qualifications must be assigned!

In addition, the operator must take into account and implement the regulations for occupational health & safety in effect at the location where the machine is operated.

#### **NOTICE!**

**Installation, operation and service must be performed by qualified, skilled personnel.**

## 2.2 Noise

The airborne noise emissions of the magnetic bearing electronics are caused exclusively by the fan installed in the integrated power supply and will depend on the installation location. Local regulations must be taken into account.

- Fan sound power level: max. 60dB(A).

## 2.3 Electrical power

The MBC1400 is operated using grid voltage, or high DC voltage. The appropriate safety precautions for handling electrical power must be complied with.



### **WARNING!**

The MBC1400 is operated with hazardous voltage and contains components for storing electrical energy. Unauthorized opening of the device and improper interventions may result in bodily injury and property damage. The device must not be opened.

## 2.4 Safety devices

The magnetic bearing electronics MBC1400 has a built-in main switch with clear On and Off markings. The LED indicators on the front (cf. Chapter 5.1.1) allow checking whether the electronics are energized.

## 2.5 Safety instructions on the device

The MBC1400 bears the following safety instructions.

### 2.5.1 Minimum discharge period after the supply has been turned Off



Figure 1: Warning label for capacitor discharge period

### 2.5.2 Hot surfaces



Hot surfaces on the housing of the magnetic bearing electronics MBC1400 (in particular, on the heat sink or cooling plate) represent a burn risk.

Severe injuries. Do not touch the magnetic bearing electronics MBC1400 until the device has cooled off sufficiently.

## 2.6 Duty cycle

The MBC1400 is generally designed for continuous operation.

### 3 Hardware configurations

The magnetic bearing electronics MBC1400 are available in different hardware configurations. The project-specific configuration of the MBC1400 can be found in the project's ML system diagram (cf. Ch. 13).

There may be several variants of the device having the same hardware configuration; their differences will lie in the project-specific calibration of their software. The software calibration relevant for the client can be found in the corresponding reports (cf. Ch. 13).

#### 3.1 Cooling plate

The heat sink with vertical louvers is required for 1400VA radial / 2800VA axial. If the amplifier output has been reduced (1000VA radial / 2000VA axial), one cooling plate will suffice. This will reduce the width of the magnetic bearing electronics MBC1400 by 20mm.

#### 3.2 Sensor connections

The following options are available for sensor connection:

	D-Sub connector	Hummel M23 circular connector
No. of connectors	1	2
No. of pins	1 x 25	2 x 12
Mount	D-Sub	M23 ext. thread
SMX8 possible	Yes	Yes
No. of sensor cables	Typically 1	2



*For operating the SMX8 sensor amplifier box, the variant with a D-Sub connector is better suited, as it will significantly reduce wiring efforts.*

#### 3.3 Magnetic bearing connection

The following options are available for magnetic bearing connection:

	Hummel M23 circular connector	Weidmüller connector
No. of connectors	3	3
No. of pins	3 x 7 (6+PE)	3 x 6 (no PE)
Mount	M23 ext. thread	None
No. of bearing cables	3	Max. of 3



*The connectors in the variant using Weidmüller connectors can neither be encoded nor firmly secured. In addition, these connectors do not have a PE pin.*

### 3.4 External pulse

Normally, the system works with an internal pulse for speed detection, which is routed into the controller via the sensor connectors. Alternatively, there is also the option of using an external pulse. Please contact MECOS in such a case.

### 3.5 Expansion module for measuring temperature

This configuration allows reading up to six external temperature sensors in two- and four-wire technology. Details on this configuration can be found in Chapter 4.7.

### 3.6 Ethernet / fieldbus interface

MECOS uses the ANYBUS™ CompactCom module as the communication bus interface (see also Ch. 4.7). These modules provide different communication solutions toward the outside, allowing the MBC1400 to communicate accordingly via these interfaces. The following interfaces are currently available:

	Profibus-DP	Ethernet I/P	Modbus TCP	EtherCAT
Connector	D-Sub9	RJ45	RJ45	RJ45
I/O data length	244Byte In 244Byte Out Max. 368 Bytes	256Byte In 256Byte Out	256Byte In 256Byte Out	256Byte In 256Byte Out
Transmission speed	9.6kbit/s - 12 Mbit/s	10/100Mbit/s	10/100Mbit/s	10/100Mbit/s



*Additional bus types such as CANOpen, CC-Link, DeviceNet, Profinet, and Sercos III are available upon request. Details can be found on the Anybus website ([www.anybus.de](http://www.anybus.de)).*

## 4 Specifications

### 4.1 Ambient conditions<sup>1</sup>

Operating temperature range	0...+55°C
Storage temperature range	-20...+60°C
Max. installation altitude	2,000m elevation <sup>2</sup>
Relative humidity	< 95% (non-condensing)

### 4.2 General data

Dimensions (L x W x H)	387 x 135 x 330mm
IP Class	IP20
Weight	12.5kg
Input voltages	100 ... 240V <sub>AC</sub> (50/60Hz) or 140 ... 340V <sub>DC</sub>
Connection overvoltage category	II
Electrical safety	IEC61010-1
UL	Prepared for certification
Power consumption (depending on machine, cable length and calibration)	Typically, 250W
Maximum current consumption	6A
Cooling	Passive (the integrated power supply has a speed-controlled fan)

### 4.3 Integrated power supply

If necessary, a maximum of two power supplies can be run in parallel (1,200W).

Manufacturer / brand	Vox Power
Type (series)	NEVO+600S
Output voltage	140V <sub>DC</sub>
Max. power output	600W at 50°C ambient temperature (525W at 55°C ambient temperature)
Reliability	< 1 FPMH (fault in a million hours)

<sup>1</sup> The MBC1400 is intended for applications in "dry & clean" environments. Applications exceeding these conditions must be discussed with MECOS during the evaluation phase.

<sup>2</sup> For applications at higher elevations, derating is possible; please contact MECOS in such a case.

#### 4.4 Motherboard and position sensors

Motherboard model	FDC261
Processor	Multi-processor system consisting of a DSP from Analog Device, an ARM9 micro-controller, and an FPGA
Sensor measuring principle	Configurable, variable excitation frequency
No. of sensor inputs	8 (4 radial, 2 axial, 2 pulse)

#### 4.5 Power amplifier

Power amplifier model	MPA1400
DC link voltage	140V <sub>DC</sub>
Amplifier type	5-axis PWM unipolar amplifier
Amplifier outputs	15 channels with integrated output filters (short-circuit-protected)
Max. power output (dynamic)	1400VA radial, 2800VA axial
No. of magnetic bearing axes	5 (4 radial, 1 axial)
Output current, radial	10A for 10s (7A continuous, 12A trip)
Output current, axial	20A for 10s (14A continuous, 24A trip)
PWM switching frequency	80kHz
Cooling	Passive; a heat sink depending on the required performance will be used

#### 4.6 Communication interfaces

### NOTICE!

**Improper connections may damage the magnetic bearing electronics.**

PC communication	
Communication interface	Ethernet (10/100Mbit/s)
Protocol	Proprietary MECOS protocol via UDP
ID	5-digit serial number
Using the MATLAB Toolbox for MECOS magnetic bearing systems (optional), complete access to the motherboard processor is possible. See Chapter 11.3.	



*The serial number for Ethernet communication is located next to the RJ45 port on the front of the MBC1400.*



Digital outputs	
No.	6
Electrical description (cf. Figure 3)	Insulated (optocoupler) outputs with common 24V supply
Max. output voltage OFF	30V <sub>DC</sub>
Max. output current ON	100mA
Description: The input functions can be calibrated, see also Ch. 5.3.	

**NOTICE!**

The digital outputs are not short circuit-protected!

Digital inputs	
No.	6
Electrical description (cf. Figure 2)	Insulated (optocoupler) input with common GND
Max. input voltage	30V <sub>DC</sub>
Min. input voltage HIGH / LOW	>10V <sub>DC</sub> / <5V <sub>DC</sub>
Input current at 24V	Max. 10mA
Description: The input functions can be calibrated.	

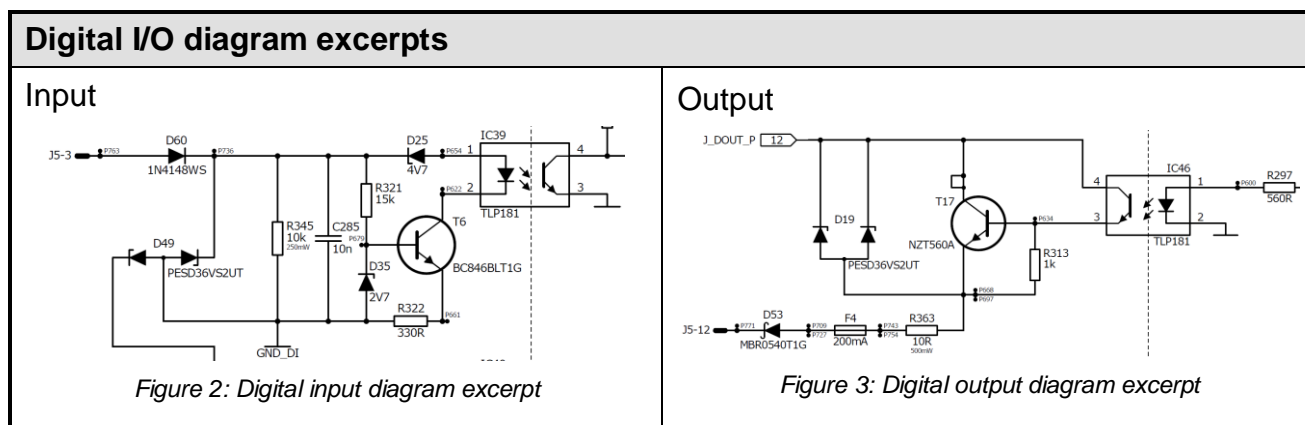

Additional information of the I/O interface can be found in Chapter 5.3.

UPS interface	
No.	4 inputs / 1 output
Electrical description	Identical with the digital I/O Cf. Figure 4 and Figure 5
Electrical parameters	Identical with the digital I/O
Description: The functions correspond to those of a typical UPS interface, but they can also be parameterised.	

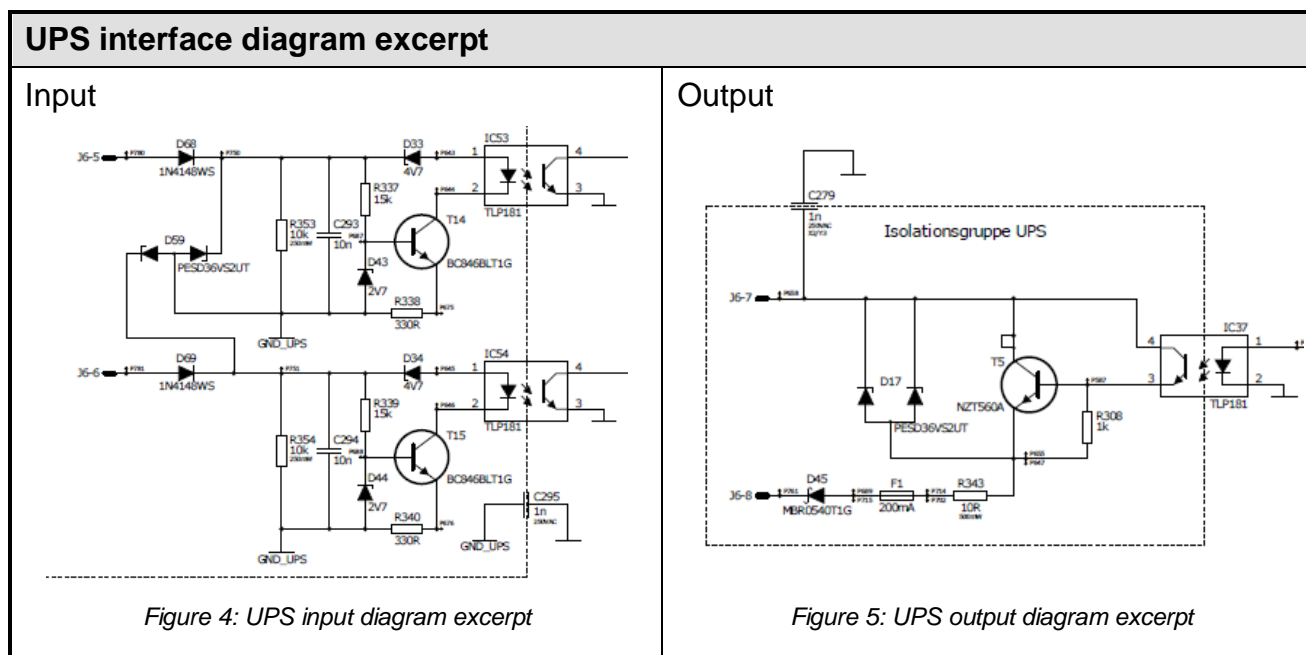

## 4.7 Expansion module

Expansion interface	
No.	1
Description: The MBC1400 has one slot for expansion modules. MECOS currently offers the following expansion cards. These expansion cards will be installed ex-works.	

**ITB6 expansion card (temperature measuring and Anybus™ slot)**

Temperature measuring

No. of sensor inputs	6
Type	PT100/PT1000, 4-wire-measuring
Measuring current	1mA

Due to the fact that two sensors have a common power supply each, sensors must always be installed in pairs. (Channels 1+2, Channels 3+4, and Channels 5+6). One channel by itself will not work.

Anybus CompactCom™ slot

No.	1
Available <sup>3</sup> Anybus CompactCom™ modules	Without communication module, Profibus DP, Ethernet/IP, Modbus TCP, EtherCAT

Figures of front faces

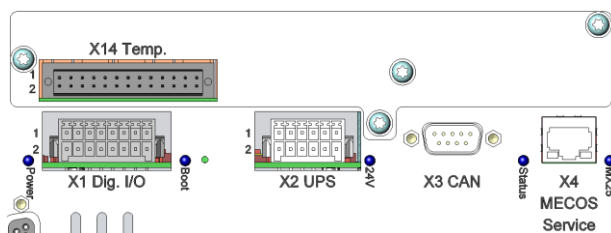

Figure 6: ITB front face w/o communication module

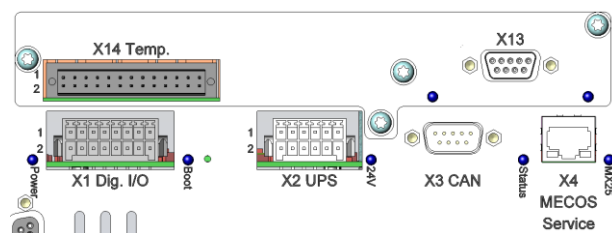

Figure 7: ITB front face with D-Sub 9-pin

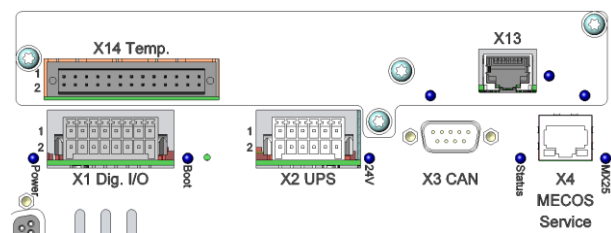

Figure 8: ITB front face with 1xRJ45

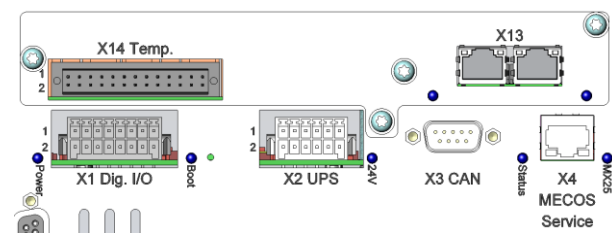

Figure 9: ITB front face with 2xRJ45

A detailed description of the Anybus CompactCom™ communication interface can be found at the Anybus website ([www.anybus.de](http://www.anybus.de)). The modules will be calibrated in coordination with Client. See Chapters 3.6 and 5.5.3.

<sup>3</sup> Generally, the complete Anybus™ range of modules will be available; if a new module type is used, additional development effort must be expected.

IBP expansion card (Anybus™ slot)	
Anybus CompactCom™ slot	
No.	1
Available <sup>4</sup> Anybus CompactCom™ modules	Profibus DP, Ethernet/IP, Modbus TCP, EtherCAT
Figures of front faces	
<p>Figure 10: Front face w/o expansion</p>	<p>Figure 11: IBP front face with D-Sub 9-pin</p>
<p>Figure 12: IBP front face with 1xRJ45</p>	<p>Figure 13: IBP front face with 2xRJ45</p>
<p> A detailed description of the Anybus CompactCom™ communication interface can be found at the Anybus website (<a href="http://www.anybus.de">www.anybus.de</a>). The modules will be calibrated in coordination with Client. See Chapters 3.6 and 5.5.3.</p>	

<sup>4</sup> Generally, the complete Anybus™ range of modules will be available; if a new module type is used, additional development effort must be expected.

## 5 Operation

### 5.1 General

The MBC1400 does not have a built-in control panel; the existing communications interfaces will be used exclusively for controlling the device during operation. For commissioning or test operation, complete access is guaranteed by means of the MATLAB Toolbox for MECOS magnetic bearing systems.

#### 5.1.1 Status indicators

The MBC1400 has several status indicators on its front face:

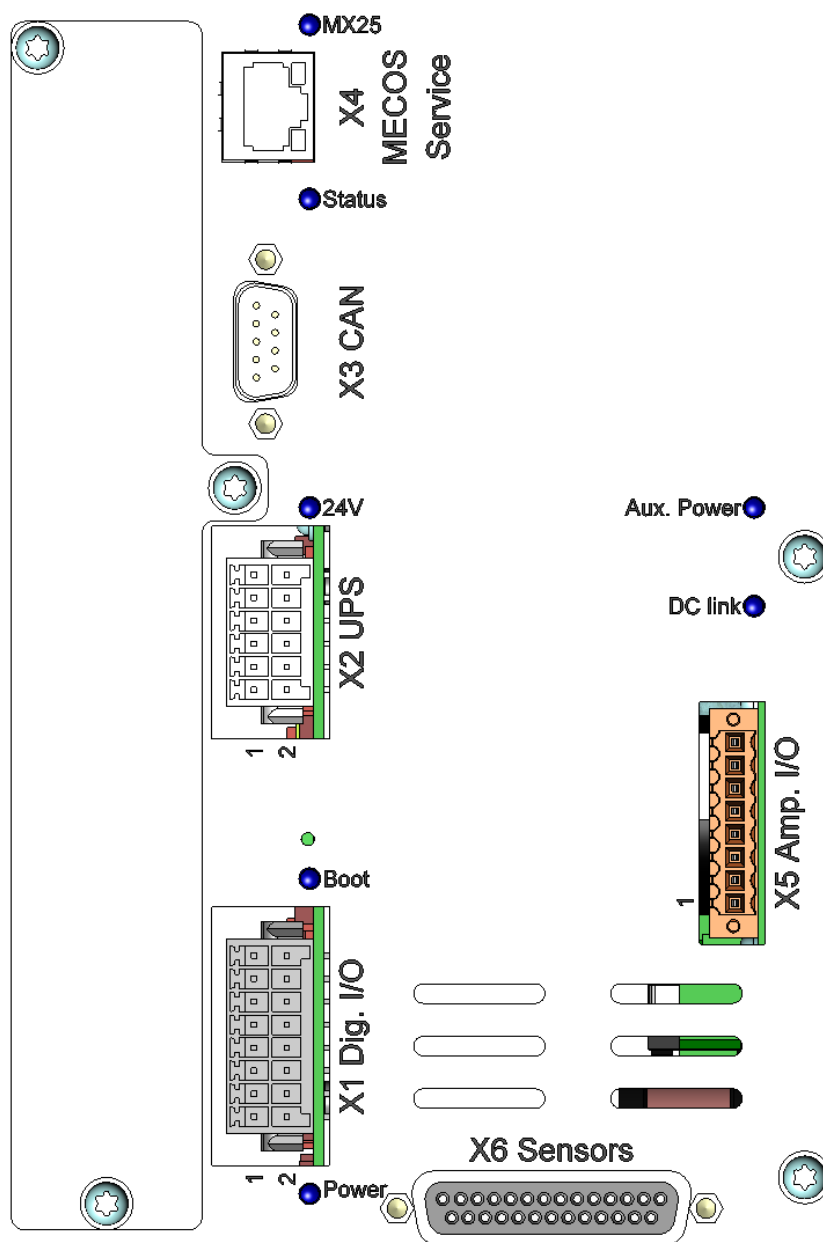

Figure 14: Status indicators

The status indicators are listed in the following table:

Designation	Description	Color
MX25	Is lit while a connection with the MBC via the Service Interface exists.	Green
Status	A fault has occurred. The rotor is levitating. The rotor is rotating.	Red Green Blue
When several states are occurring, the corresponding mixed colors will be shown: Red + Green = Yellow, Red + Blue = Magenta, Green + Blue = Cyan, Red + Green + Blue = White		
24V	Is lit while the insulated 24V voltage exists.	Green
Boot	Is lit while the controller is in the Boot mode.	Red
Logic power	Is lit while the auxiliary voltages from the controller exist.	Green
Aux. power	Is lit while the secondary voltage from the amplifier board exists.	Green
DC link	Is lit while the DC link voltage is energizing the amplifier board.	Orange

## 5.2 Boot button

If, during the boot process, the boot button is pressed and held, the controller can be put into the boot mode. After the boot button has been activated, the magnetic bearing system cannot be activated (MBC1400 is permanently in boot mode).

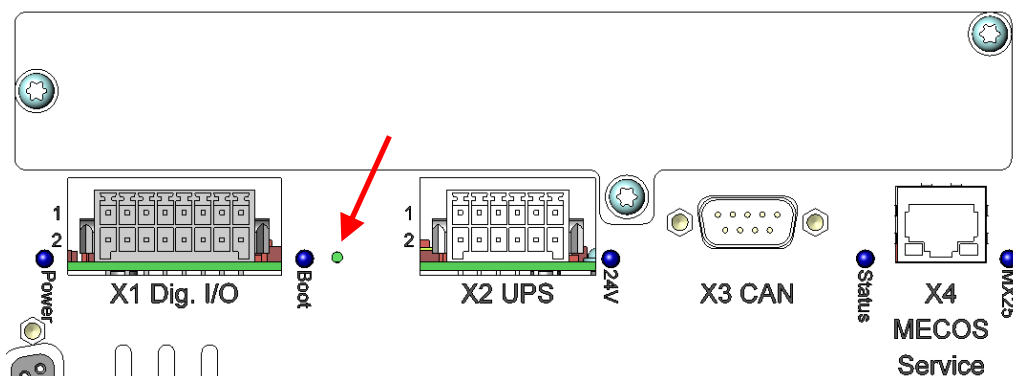

Figure 15: Boot button

### NOTICE!

The boot button may only be pressed by a MECOS service technician, or by accordingly trained personnel, in case of a magnetic bearing amplifier fault.

### 5.3 Operation via the digital I/O interface

Communication between the magnetic bearing electronics and the higher-order control system will be performed via the digital I/O interface, and/or – if available – via the expansion card communication bus. The interface pin assignment is defined according to the connection diagram (cf. Chapter 13). The connectors are described in Chapter 6.2.

### 5.4 Operation via the PC interface (optional)

Complete access is possible via Ethernet using the MATLAB Toolbox for MECOS magnetic bearing systems (optional). In addition to the control functions, the Toolbox has many different tools for calibrating and analyzing the magnetic bearing system.



*The functionalities of the MATLAB Toolbox are described in Chapter 11.3.*

## 5.5 Calibrating the communication interfaces

The MBC1400 has a large number of parameters that will be project-specifically defined. Calibration will be performed via the PC interface (cf. Ch. 5.4); only restricted client changes will be possible, as incorrect calibration may result in malfunction of, or in damage to or destruction of the system. MECOS will supply the controller with the appropriate calibration, and subsequent configuration changes will only be possible and permitted in coordination with MECOS and in cooperation with a service technician or service personnel accredited by MECOS. This document includes the reference to the corresponding calibration reports (cf. Ch. 13), which will be generated specifically for each project.

### 5.5.1 Digital I/O configuration

This report includes the information for calibrating the digital inputs and outputs, as well as the UPS interface.

### 5.5.2 Monitoring parameters

The monitoring report includes all of the calibration information for the monitoring interface. In addition to the bit and fault numbers for identification purposes, there is also a description for each parameter, the information on its lower and upper limits, as well as the fault reaction that has been calibrated. The corresponding columns are labelled and come with an explanation. Details on fault reaction can be found in Chapter 10.

### 5.5.3 Anybus variables

The Anybus calibration report includes all of the calibration information for the Anybus™ interface (if applicable). For each available variable, the report will provide the necessary address, type, and access information, unit info, range info, as well as a description of the variable. The corresponding columns are labelled and come with an explanation. Depending on the bus type, the columns may slightly differ.

## 5.6 Additional operating instructions



### CAUTION!

**While the magnetic bearing electronics MBC1400 are ON, cables may not be plugged in/unplugged. Otherwise, this may result in electric shock, or in the dropping of the rotor while in the rotating state.**



*In order to prevent potential data loss, magnetic data media such as diskettes, hard disks, etc. must not be stored in the direct vicinity of the magnetic bearing electronics.*



## 6 Assembly and installation

### **WARNING!**

Check the magnetic bearing electronics for transport damage during unpacking. Visibly damaged devices must never be connected to grid power. Promptly report any transport damage to the manufacturer. The original packaging must be saved.

### **DANGER!**

The device may only be set up and commissioned by qualified skilled technical personnel, and while the grid power cable is disconnected. Please comply with the safety instructions in Chapter 2.

### 6.1 Assembly view<sup>5</sup>

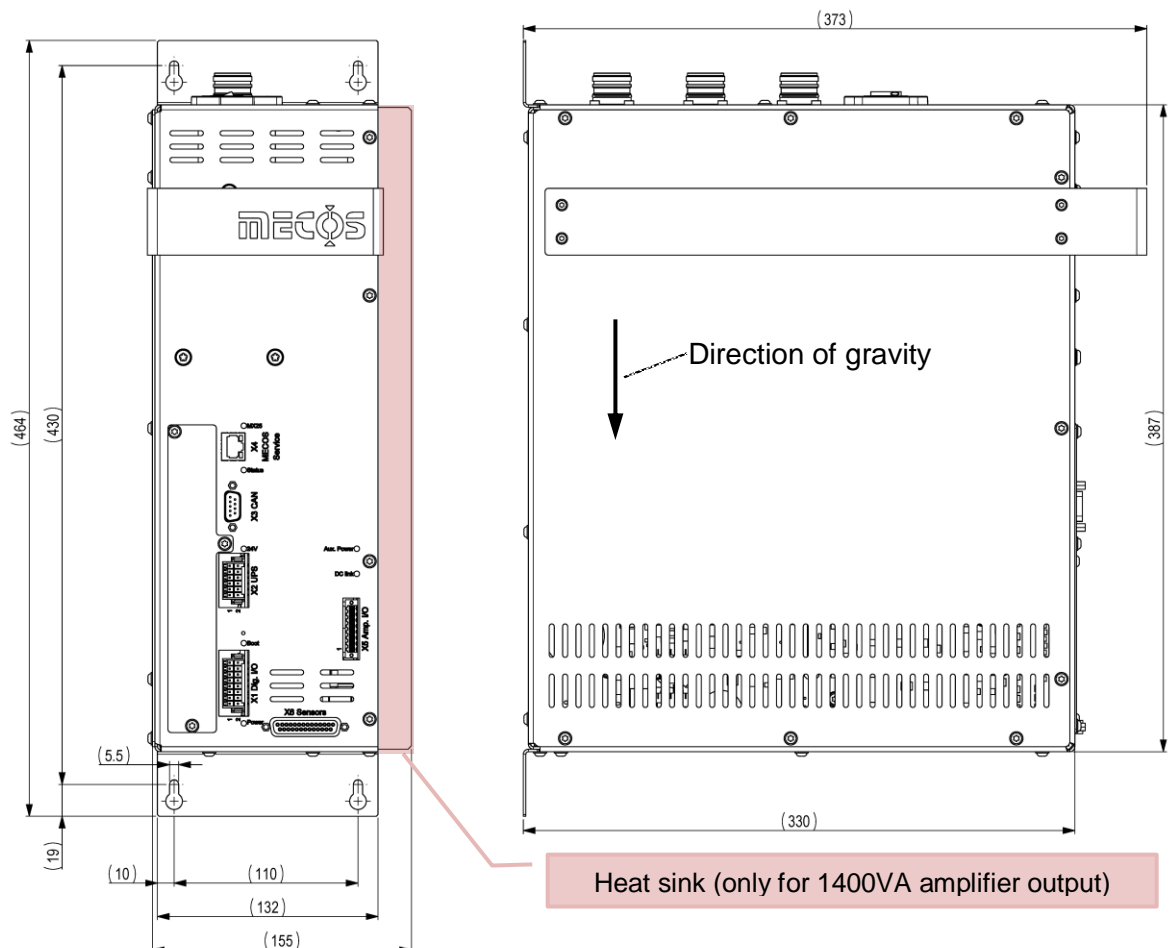

Figure 16: Assembly view – variant with heat sink, Hummel M23 bearing connector, and D-Sub sensor connector

<sup>5</sup> The assembly view may differ depending on configuration of connectors, expansion modules, and amplifier output.

The magnetic bearing electronics MBC1400 must be installed in a switch cabinet. It shall be installed in the vertical position (cf. Figure 16).

Use the four attachment points provided for this purpose on the back wall of the device. Use appropriate M5 bolts for mounting.

To ensure proper cooling of the MBC1400, a minimum clearance of 60mm for supply and exhaust air (cf. Chapter 6.4) must be ensured.

 *The installation plate must be grounded.*



## **DANGER!**

The device may only be set up and commissioned by qualified skilled technical personnel, and with the main switch turned to OFF, and the grid power cable disconnected. Please comply with the safety instructions in Chapter 2.

## **NOTICE!**

The clearances for cooling the MBC1400 must be observed. If the minimum clearances specified are not ensured, the reduced air circulation may result in overheating of the magnetic bearing electronics, which in turn may result in an untimely shutdown of the controller.

## 6.2 Electrical connections

### DANGER!

The magnetic bearing electronics may not be turned ON until all of the connections have been made properly. The grid connections of all devices must be made last. When routing the connection cables, make sure that they are neither pinched, nor routed over sharp corners and edges.

### NOTICE!

Make sure that the local AC grid supply and/or the DC supply voltage matches the input voltage range of the MBC1400 (cf. Ch. 4).

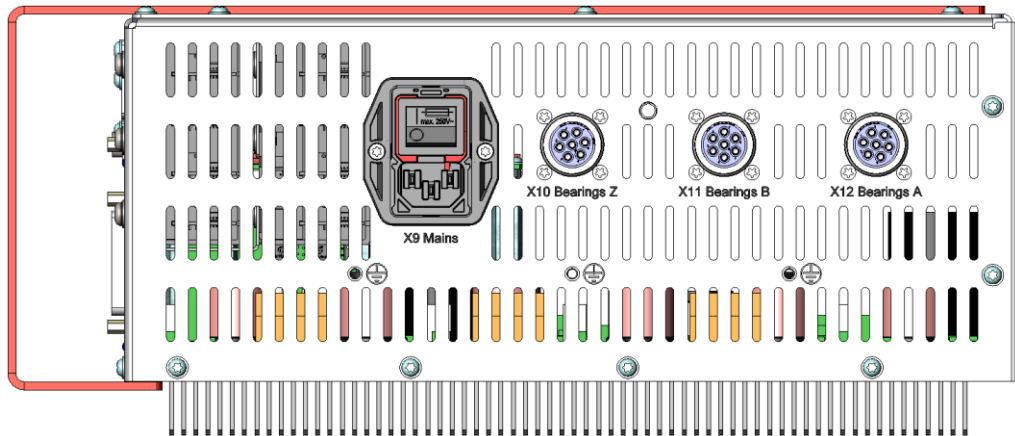

Figure 17: Top of the MBC1400 (variant with heatsink and Hummel connectors)

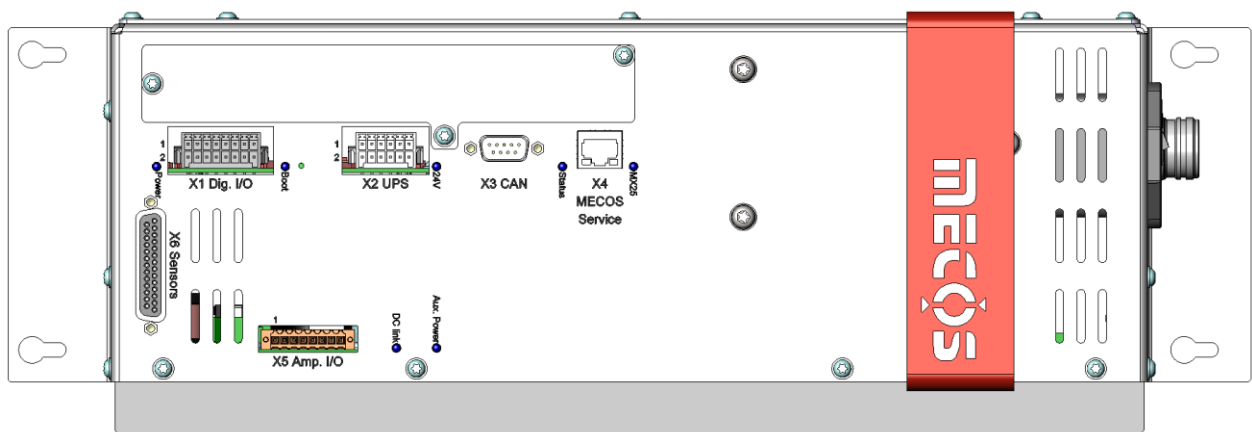

Figure 18: Front of the MBC1400 (variant with heatsink and Hummel connectors)

The pin assignment of the electrical connections has been defined according to the connection diagram (cf. Ch. 13). The following connections are located on the front of the MBC1400:

### X1 Dig. I/O

(WAGO, MBC: 713-1428/116-000, cable: 713-1108/037-000)

X1 is a 16-pin Wago connector for communication between client interface and MBC1400 via digital in- and outputs. 6 digital inputs (DI1-6) and 6 digital outputs (DO1-6) are available for this purpose. In addition, the external power supply for the digital outputs can be connected to connector pins 9 and 10.

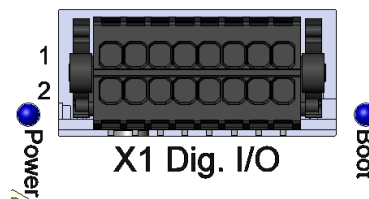

Figure 19: X1 connector

**⚠** When making the connection, make sure that the connector remains securely plugged in by using its integrated mounting mechanism.

Pin no.	Designation	Description
1	DI_GND	GND of the digital inputs, common GND for all DI
2	DI_GND	GND of the digital inputs, common GND for all DI
3	DI1	Digital input 1
4	DI2	Digital input 2
5	DI3	Digital input 3
6	DI4	Digital input 4
7	DI5	Digital input 5
8	DI6	Digital input 6
9	DO_P	Digital output supply, common ext. supply for all DO
10	DO_P	Digital output supply, common ext. supply for all DO
11	DO1	Digital output 1
12	DO2	Digital output 2
13	DO3	Digital output 3
14	DO4	Digital output 4
15	DO5	Digital output 5
16	DO6	Digital output 6

## NOTICE!

Max. voltage and current values of the digital I/O must be complied with, as otherwise, the hardware may be damaged (cf. Chapter 4.6).

**X2 UPS****(WAGO, MBC: 713-1426/116-000, cable: 713-1106/037-000)**

The 12-pin X2 connector is used for communication between a UPS and the magnetic bearing electronics.

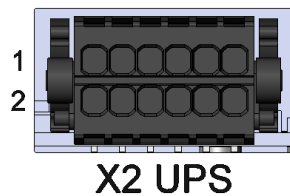

Figure 20: X2 connector

**⚠** When making the connection, make sure that the connector remains securely plugged in by using its integrated mounting mechanism.

Pin no.	Designation	Description
1	GND_UPS	GND of the UPS digital inputs, common GND for all DI
2	GND_UPS	GND of the UPS digital inputs, common GND for all DI
3	DI1_UPS	Digital input 1
4	DI2_UPS	Digital input 2
5	DI3_UPS	Digital input 3
6	DI4_UPS	Digital input 4
7	DO_UPS_P	Digital output supply
8	DO_UPS	Digital output
9	+24V_ISO	Insulated 24V voltage (output voltage for Dig. I/O)
10	+24V_ISO	Insulated 24V voltage (output voltage for Dig. I/O)
11	GND_ISO	GND of the insulated 24V voltage
12	GND_ISO	GND of the insulated 24V voltage



The functions of the individual in- and outputs can be calibrated (cf. Ch. 5.5.1).

## NOTICE!

**Max. voltage and current values of the digital I/O must be complied with, as otherwise, the hardware may be damaged (cf. Chapter 4.6).**

**X3 CAN****(MBC: D-Sub 9-pin male, cable: D-Sub 9-pin female)**

CAN communication via 9-pin D-Sub connector. Intended for future expansions; MECOS is currently not offering any compatible devices for this interface.

**X3 CAN**

Figure 21: X3 connector



*This interface is not a complete CAN-Open interface. Details may be requested from MECOS.*

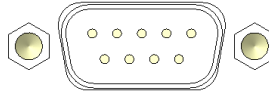

*When making the connection, make sure that the connector remains securely plugged in by using its integrated mounting mechanism.*

Pin no.	Designation	Description
1	-	Not assigned
2	CAN_L	CAN Low
3	GND	GND
4	-	Not assigned
5	GND	GND
6	GND	GND
7	CAN_H	CAN High
8	-	-
9	U_EM_CAN	12V supply for expansion module (max. current: 500mA)

### X4 MECOS Service (MBC: RJ45 socket, cable: RJ45 plug)

The X4 Ethernet socket allows PC communication by means of a commercial network cable. The MATLAB Toolbox for MECOS magnetic bearing systems (optional) allows complete access to the motherboard processor.

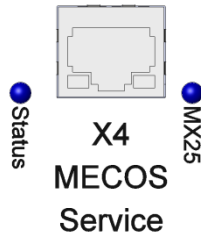

Figure 22: X4 connector



The connection can be made directly, or via a switch.

### X5 Amp. I/O (Weidmüller, MBC: SL3.50/08/90F 3.2SN OR BX, cable: BLZF3.50/08/180F SN OR BX)

The 8-pin Weidmüller connector allows controlling up to two external relays (ground switched via transistor) and connecting up to two external NTC sensors.

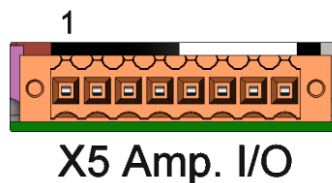

Figure 23: X5 connector

Pin no.	Designation	Description
1	-	Not assigned
2	RELAY_1	Switched connection ext. relay 1 to GND
3	U_EM_CAN	12V voltage supply for relays 1 and 2 (max. 1A)
4	RELAY_2	Switched connection ext. relay 2 to GND
5	NTC_1	Connection of an external NTC sensor with a resistance ( $R_{25}$ ) of 10k $\Omega$
6	GND	GND for NTC
7	NTC_2	Connection of an external NTC sensor with a resistance ( $R_{25}$ ) of 10k $\Omega$
8	GND	GND for NTC

### X6 sensors (MBC1400 variant with D-Sub sensor connector) (MBC: D-Sub 25-pin female, cable: D-Sub 25-pin male)

X6 is used to connect the sensors for detecting rotor position in planes A, B, and Z, as well as pulse.



For cable lengths >10m, a sensor amplifier box (SMX8, cf. Ch. 11.1) for improving sensor signal quality should be used.

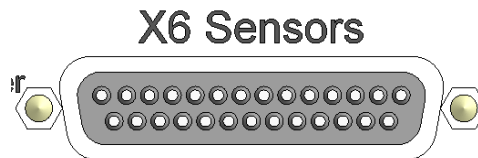

Figure 24: X6 connector (MBC1400 variant D-Sub sensor connector)



When making the connection, make sure that the connector remains securely plugged in by using its integrated mounting mechanism.

Pin no.	Designation	Description
1	IN_EXT_ID	Cable / machine ID
2	S_IN_AX_P	Position, X-axis, P-direction, bearing / plane A
3	S_IN_AY_P	Position, Y-axis, P-direction, bearing / plane A
4	S_IN_BX_P	Position, X-axis, P-direction, bearing / plane B
5	S_IN_BY_P	Position, Y-axis, P-direction, bearing / plane B
6	S_IN_Z1_P	Position, Z-axis (Z1), P-direction
7	S_IN_COS_P	Pulse, cosine input (Pulse 1), plus
8	S_GND	Signal GND
9	S_IN_Z2_P	Position, Z-axis (Z2), P-direction
10	S_IN_SIN_P	Pulse, sine input (Pulse 2), plus
11	U_SENS	Voltage supply for SMX8
12	EXC_S_P	Plus excitation signal for SMX8
13, 14	GND	Housing GND
15	S_IN_AX_N	Position, X-axis, N-direction, bearing / plane A
16	S_IN_AY_N	Position, Y-axis, N-direction, bearing / plane A
17	S_IN_BX_N	Position, X-axis, N-direction, bearing / plane B
18	S_IN_AY_N	Position, Y-axis, N-direction, bearing / plane B
19	S_IN_Z1_N	Position, Z-axis (Z1), N-direction
20	S_IN_COS_N	Pulse, cosine input (Pulse 1), minus



21	S_GND	Signal GND
22	S_IN_Z2_N	Position, Z-axis (Z2), N-direction
23	S_IN_SIN_N	Pulse, sine input (Pulse 2), minus
24	U_SENS	Voltage supply for SMX8
25	EXC_S_N	Minus excitation signal for SMX8

### X7/X8 Sensors A / Sensors B (MBC1400 variant with Hummel sensor connector) (Hummel M23, for details see Magnetic bearing system diagram, Ch. 13)

X7 and X8 are used for connecting the sensors for detecting the rotor position in planes A, B, and Z, as well as the pulse. X7 and X8 are 12-pin M23 industrial connectors from Hummel.



For cable lengths >10m, a sensor amplifier box (SMX8, cf. Ch. 11.1) for improving the sensor signal quality should be used.

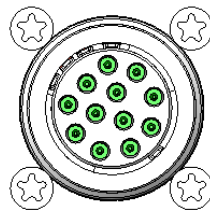

X7

Sensors A

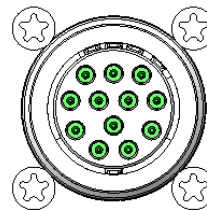

X8

Sensors B

Figure 25: X7 / X8 connectors (MBC1400 variant Hummel sensor connectors)



The X7 and X8 connectors are encoded. Encoding is intended to prevent wires from being improperly connected; however, the encoding may be damaged if handled improperly. This must be taken into account during installation.



Experience has shown that assembly and installation of the Hummel connectors at clients' facilities keep causing problems. MECOS has instructions for Hummel connector assembly and installation that may be requested by clients.

**X7 Sensor A (MBC1400 variant with Hummel sensor connectors):**

Pin no.	Designation	Description
1	S_IN_AX_P	Position, X-axis, P-direction, bearing / plane A
2	S_IN_AX_N	Position, X-axis, N-direction, bearing / plane A
3	S_IN_AY_P	Position, Y-axis, P-direction, bearing / plane A
4	S_IN_AY_N	Position, Y-axis, N-direction, bearing / plane A
5	S_IN_Z1_P	Position, Z-axis (Z1), P-direction
6	S_IN_Z1_N	Position, Z-axis (Z1), N-direction
7	EXC_S_N	Excitation signal N for sensor amplifier box SMX8
8	EXC_S_P	Excitation signal P for sensor amplifier box SMX8
9	U_SENS	Voltage supply for sensor amplifier box SMX8
10	U_SENS	Voltage supply for sensor amplifier box SMX8
11	GND	Housing GND
12	S_GND	Signal GND

**X8 Sensor B (MBC1400 variant with Hummel sensor connectors):**

Pin No.	Designation	Description
1	S_IN_BX_P	Position, X-axis, P-direction, bearing / plane B
2	S_IN_BX_N	Position, X-axis, N-direction, bearing / plane B
3	S_IN_BY_P	Position, Y-axis, P-direction, bearing / plane B
4	S_IN_BY_N	Position, Y-axis, N-direction, bearing / plane B
5	S_IN_Z2_P	Position, Z-axis (Z2), P-direction
6	S_IN_Z2_N	Position, Z-axis (Z2), N-direction
7	S_IN_COS_P	Pulse, cosine input (Pulse 1), plus
8	S_IN_COS_N	Pulse, cosine input (Pulse 1), minus
9	S_IN_SIN_P	Pulse, sine input (Pulse 2), plus
10	S_IN_SIN_N	Pulse, sine input (Pulse 2), minus
11	n.c.	Not assigned
12	S_GND	Signal GND

## X9 MAINS

**(MBC: IEC C14 electrical device plug, cable IEC C13 electrical device socket)**

X9 is an electrical device plug with integrated fuses and a grid power switch for connecting a power supply according to Chapter 4.2.

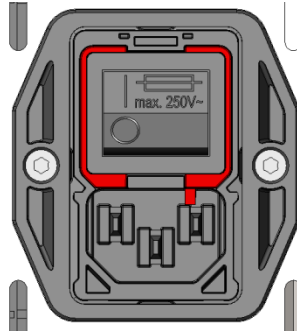

Figure 26: X9 connector

**⚠** The grid connector does not have a mounting mechanism as it is located on the top of the magnetic bearing electronics MBC1400, and the standard for IEC connectors does not provide for such a mechanism. However, the manufacturer Schaffner can supply a grid cable that can be firmly secured (IL 13 grid cable series). For additional information, please contact MECOS.

Pin no.	Description
L	Live / DC+
PE	Earth
N	Neutral / DC-



Two 5x20mm 6.3A fast, sand-filled ceramic tube fuses (Littelfuse 021606.3MXP) are installed ex-works. These may only be replaced by equivalent fuses with a UL certificate. A straight-blade screwdriver No. 1 or smaller can be used to pry out the insert containing the grid power switch and fuse holder:



Figure 27: Excerpt from the IEC datasheet of plug-in filter from Schaffner (FN 9290)

### X10/X11/X12 Bearings Z / Bearings B / Bearings A (MBC1400 variant Hummel) (Hummel M23, for details see Magnetic bearing system diagram, Ch. 13)

The X10-X12 connectors are used to connect the radial bearings of planes A and B, as well as the axial bearing. The bearing plugs are Series M23 industrial plugs from Hummel.

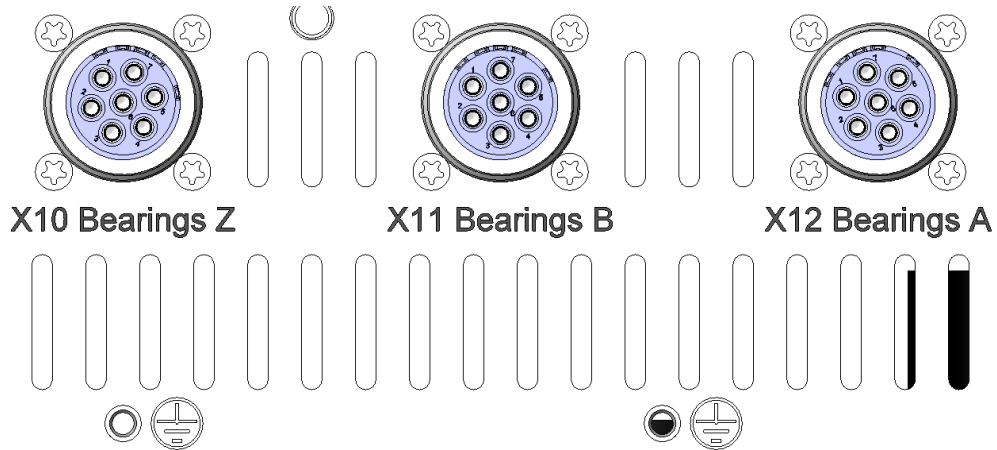

Figure 28: X10-X12 connectors (MBC1400 variant Hummel bearing connectors)

**⚠** The X10-X12 are encoded. Encoding is intended to prevent wires from being improperly connected; however, the encoding may be damaged if handled improperly. This must be taken into account during installation.

**💡** Experience has shown that assembly and installation of the Hummel connectors at clients' facilities keep causing problems. MECOS has instructions for Hummel connector assembly and installation that may be requested by clients.

## **⚠ DANGER!**

As the bearing outputs are buffered via capacitors, residual voltage may be present at the bearing outputs for a certain period of time (see Ch. 2.5.1) even if the power supply has already been turned off. Connector installation may only be performed by trained personnel.

**X10 Bearings Z (MBC1400 variant with Hummel bearing connectors):**

Pin no.	Designation	Description
1	OUT_ZP	Axial bearing Z-axis connection: Plus
2	OUT_ZC	Axial bearing Z-axis connection: Common
3	OUT_ZC	Axial bearing Z-axis connection: Common
4	OUT_ZN	Axial bearing Z-axis connection: Minus
5	OUT_ZN	Axial bearing Z-axis connection: Minus
6	OUT_ZP	Axial bearing Z-axis connection: Plus
7	PE	Protective lead

**X11 Bearings B (MBC1400 variant with Hummel bearing connectors):**

Pin no.	Designation	Description
1	OUT_BXP	Radial bearing B, X-axis connection: Plus
2	OUT_BXC	Radial bearing B, X-axis connection: Common
3	OUT_BXN	Radial bearing B, X-axis connection: Minus
4	OUT_BYP	Radial bearing B, Y-axis connection: Plus
5	OUT_BYC	Radial bearing B, Y-axis connection: Common
6	OUT_BYN	Radial bearing B, Y-axis connection: Minus
7	PE	Protective lead

**X12 Bearings A (MBC1400 variant with Hummel bearing connectors):**

Pin no.	Designation	Description
1	OUT_AXP	Radial bearing B, X-axis connection: Plus
2	OUT_AXC	Radial bearing B, X-axis connection: Common
3	OUT_AXN	Radial bearing B, X-axis connection: Minus
4	OUT_AYP	Radial bearing B, Y-axis connection: Plus
5	OUT_AYC	Radial bearing B, Y-axis connection: Common
6	OUT_AYN	Radial bearing B, Y-axis connection: Minus
7	PE	Protective lead

### X10/X11/X12 Bearings Z / Bearings B / Bearings A (MBC1400 variant Weidmüller) (Weidmüller, MBC: BLL 5.08/10/90FI 3.2SN OR, cable: SLF 5.08/06/180FI SN OR)

The X10-X12 connectors are used to connect radial bearings of planes A and B, as well as axial bearings. The bearing connectors come directly from the motherboard, which is why mechanical mounting mechanisms are not allowed due to the mechanical loads. The variant with Hummel M23 connectors is the more robust variant for bearing connectors with a mounting mechanism.

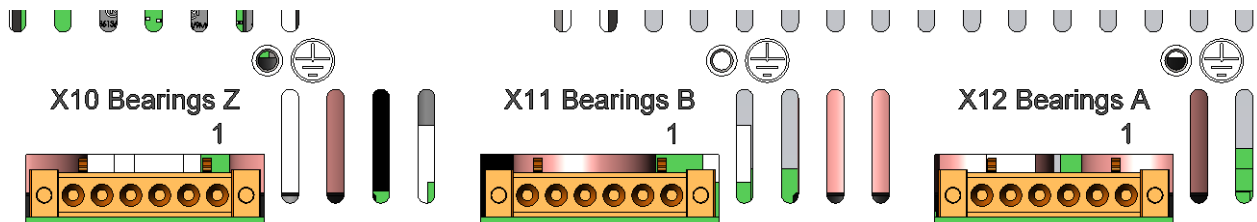

Figure 29: X10-X12 connectors (MBC1400 variant Weidmüller bearing connectors)



**DANGER!**

As the bearing outputs are buffered via capacitors, residual voltage may be present at the bearing outputs for a certain period of time (see Chapter 2.5.1) even if the power supply has already been turned off. Connector installation may only be performed by trained personnel.



**DANGER!**

For secure grounding between the machine and the MBC1400 housing, three M4 threaded sockets are available directly next to the bearing outputs. The MBC1400 variant Weidmüller does not have a separate PE connection on the 6-pin bearing connectors, which is why this connection must be made using the threaded ME connections. See Chapter 6.3.

**X10 Bearings Z (MBC1400 variant with Weidmüller bearing connector):**

Pin no.	Designation	Description
1 (A)	OUT_ZP	Axial bearing Z-axis connection: Plus
2 (B)	OUT_ZP	Axial bearing Z-axis connection: Plus
3 (C)	OUT_ZC	Axial bearing Z-axis connection: Common
4 (D)	OUT_ZC	Axial bearing Z-axis connection: Common
5 (E)	OUT_ZN	Axial bearing Z-axis connection: Minus
6 (F)	OUT_ZN	Axial bearing Z-axis connection: Minus

**X11 Bearings B (MBC1400 variant with Weidmüller bearing connector):**

Pin no.	Designation	Description
1 (A)	OUT_BXP	Radial bearing B, X-axis connection: Plus
2 (B)	OUT_BXC	Radial bearing B, X-axis connection: Common
3 (C)	OUT_BXN	Radial bearing B, X-axis connection: Minus
4 (D)	OUT_BYP	Radial bearing B, Y-axis connection: Plus
5 (E)	OUT_BYC	Radial bearing B, Y-axis connection: Common
6 (F)	OUT_BYN	Radial bearing B, Y-axis connection: Minus

**X12 Bearings A (MBC1400 variant with Weidmüller bearing connector):**

Pin no.	Designation	Description
1 (A)	OUT_AXP	Radial bearing A, X-axis connection: Plus
2 (B)	OUT_AXC	Radial bearing A, X-axis connection: Common
3 (C)	OUT_AXN	Radial bearing A, X-axis connection: Minus
4 (D)	OUT_AYP	Radial bearing A, Y-axis connection: Plus
5 (E)	OUT_AYC	Radial bearing A, Y-axis connection: Common
6 (F)	OUT_AYN	Radial bearing A, Y-axis connection: Minus

### X13-X14 expansion module connectors

The connectors listed below only apply to expansion cards. The expansion cards available are described in Chapter 4.7.

#### X13 Anybus™ slot (for ITB6 and IBP expansion cards) (depending on the Anybus™ module selected)

X13 is an Anybus™ slot with a corresponding communication interface. The interface type and the corresponding parameter list will determine the type and content of the communication via this interface. Details on the interface can be found in the corresponding list of Anybus variables (cf. Ch. 13).

#### X14 Temp. (for ITB6 expansion card)

**(Weidmüller, MBC: S2L-SMT3.5/26/90 LF3.2SN, cable: B2L 3.50/26/180F SN BK BX)**

The 26-pin Wago connector can be used for connecting up to six PT100/PT1000 temperature sensors of the magnetic bearing. The sensor resistance can be measured using 2- or 4-wire technology. For measuring sensor voltage only (2-wire technology), the connector pins TEMP1-2 and TEMP1-3 will be connected to the sensor. For additional measuring using a constant-current source (4-wire technology), TEMP1-1 and TEMP1-4 must additionally be connected, as shown in the schematic diagram.

 *When making the connection, make sure that the connector remains securely plugged in by using its integrated mounting mechanism.*

Pin no.	Function	Description
1	TEMP1-1	Sensor 1: Connection 1 (current measurement +)
2	TEMP1-2	Sensor 1: Connection 2 (voltage measurement +)
3	TEMP1-3	Sensor 1: Connection 3 (voltage measurement -)
4	TEMP1-4	Sensor 1: Connection 4 (current measurement -)
5	TEMP2-1	Sensor 2: Connection 1 (current measurement +)
6	TEMP2-2	Sensor 2: Connection 2 (voltage measurement +)
7	TEMP2-3	Sensor 2: Connection 3 (voltage measurement -)
8	TEMP2-4	Sensor 2: Connection 4 (current measurement -)
9	PE_AIO	Sensor GND / shield
10	PE_AIO	Sensor GND / shield
11	TEMP3-1	Sensor 3: Connection 1 (current measurement +)
12	TEMP3-2	Sensor 3: Connection 2 (voltage measurement +)
13	TEMP3-3	Sensor 3: Connection 3 (voltage measurement -)
14	TEMP3-4	Sensor 3: Connection 4 (current measurement -)



15	TEMP4-1	Sensor 4: Connection 1 (current measurement +)
16	TEMP4-2	Sensor 4: Connection 2 (voltage measurement +)
17	TEMP4-3	Sensor 4: Connection 3 (voltage measurement -)
18	TEMP4-4	Sensor 4: Connection 4 (current measurement -)
19	TEMP5-1	Sensor 5: Connection 1 (current measurement +)
20	TEMP5-2	Sensor 5: Connection 2 (voltage measurement +)
21	TEMP5-3	Sensor 5: Connection 3 (voltage measurement -)
22	TEMP5-4	Sensor 5: Connection 4 (current measurement -)
23	TEMP6-1	Sensor 6: Connection 1 (current measurement +)
24	TEMP6-2	Sensor 6: Connection 2 (voltage measurement +)
25	TEMP6-3	Sensor 6: Connection 3 (voltage measurement -)
26	TEMP6-4	Sensor 6: Connection 4 (current measurement -)

## NOTICE!

Due to the fact that two sensors each have a common power supply, sensors must always be connected as a pair (Channels 1+2, Channels 3+4, and Channels 5+6). A single channel will not work (cf. Chapter 4.7).

### 6.3 Protective GND connections (housing)

## DANGER!

Risk of electrocution due to a lack of or improper grounding. Without grounding, in case of a fault, personal injuries may be caused by hazardous voltages on the housing. For secure operation of the MBC1400, controlled, proper and safe grounding is mandatory.

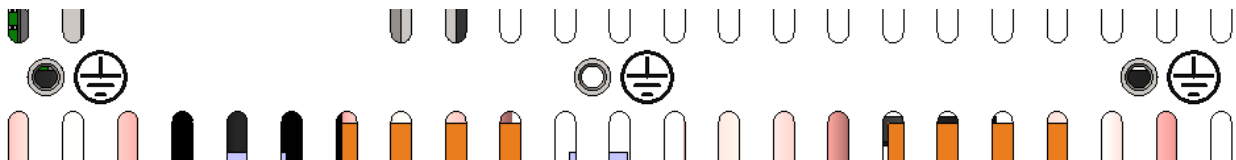



Figure 30: Protective ground connections on the MBC1400 housing

For secure grounding of the MBC1400 housing, three M4 threaded sockets are provided on the top. Please ensure that the connections are made. The PE connection must have a cross-section of at least 2.5mm<sup>2</sup>.

 When making the connection, ensure that the ground connection is firmly secured with bolts and locking washers against coming loose.

Recommendation: Serrated washers BN792, torque 1.2Nm

## 6.4 Ventilation

The switch cabinet ventilation must comply with the conditions specified in Chapter 4. Ensure that there is sufficient clearance between adjacent components and the magnetic bearing electronics MBC1400 so that the air can always keep moving.

A minimum clearance of 60 mm around the MBC1400 housing must be complied with. In addition it must be ensured that the switch cabinet ventilation has a minimum airflow of >1 m/s on the heat sink/cooling plate side (on the right).

### NOTICE!

**If the airflow in the switch cabinet is insufficient, in particular, on the heat sink/cooling plate side of the magnetic bearing electronics MBC1400, the full amplifier output cannot be warranted. As a consequence, the rotor might be dropped while rotating.**

## 6.5 EMC regulations

For operation in conformity with the EMC Directive, the installation plate must be grounded for shedding high-frequency noise signals. The magnetic bearing electronics MBC1400 has a built-in, two-stage connector filter, so that no further EMC measures will be necessary.

## 6.6 Additional instructions

- Never exceed the specified maximum temperature (cf. Chapter 4.1);
- Ensure that the ventilation in the switch cabinet is sufficient (cf. Chapter 6.4);
- Avoid any contact with the electronic components;
- Do not operate the magnetic bearing electronics in an explosive atmosphere.

## 7 Cleaning and maintenance

The magnetic bearing electronics is not subject to wear in operation according to its intended use (cf. Chapter 2.1.1) and is thus maintenance-free.



### **DANGER!**

**Device must never come in contact with water or other liquids. Never use any objects to get into the device.**

## 8 Disposal and recycling

When the magnetic bearing electronics is decommissioned at the end of its lifecycle, the disposal laws and regulations applicable at that time must be complied with.

It makes sense to check which materials are recyclable, and to do so.

## 9 Transport

For longer transports, and specifically for transports in the open air, the original packaging of the magnetic bearing electronics must be used to protect the device from shock and humidity. Thus, the original packaging must always be saved.

For transports within a building, special precautions for packaging need not be taken. It must, however, be ensured that the electronics are not exposed to any shocks or loads.

## 10 Malfuncions

Personnel that is to be trained, receiving an orientation, or that is in a general training program, may only work at the magnetic bearing electronics under the constant supervision of an experienced, skilled employee!

A malfunction may occur for a variety of causes. Always try to initially find out whether the cause of the malfunction lies in the system itself, or in inadmissible ambient conditions (cf. Chapter 4.1).

In the magnetic bearing electronics MBC1400, continuous monitoring of a large number of system states will be performed. Faults and warnings will generally be issued via the digital I/O, the X4 service interface, or the optional fieldbus interface. Details on these interfaces can, unless they are described in this document, be found in the associated document (cf. Chapter 13).

If connecting via the service or fieldbus interface is not possible, the Service of MECOS AG (cf. Chapter 1.4) must always be notified.

The system's fault response depends on its calibration, see also Chapter 5.5.2. The monitoring depends on the signal type (analog or digital). In addition to the monitoring limit / level, a delay period can also be calibrated.



*Please contact MECOS if faults occur repeatedly.*

MECOS distinguishes between Warning and Fault:

Designation	Description
Warning	Will generate a warning message (alarm). An alarm will be triggered if a warning limit has been exceeded; it will remain set until it falls below the warning limit again and the minimum period for the warning has expired. An alarm will not usually result in a reaction.
Fault	Will generate an error message (Error) An error message will be triggered if a system-critical limit is exceeded. An error will usually result in an error response; it will remain set until it is reset by a delete command. An error cannot be reset as long as the error exists.

Both Warning and Fault can be hidden. The following behaviours can be set:

Designation	Description
noAction	No response
Stop	Stop the drive (emergency stop)
Liftdown	Lower the rotor (only during standstill or at low rpms possible)
Dropdown	Immediate dropping of the rotor at rpms
ResetDisable	Locks error reset until the next restart
ResetNotRot	Error can only be reset during standstill
LevitatedOnly	Monitoring is only active with levitating rotor
History	Entry in error memory's SPI-Flash (fault history)
EventLog	Entry in event logger's SPI-Flash (event log)

## 10.1 Overload

When an overload occurs, the integrated power supply will enter a protective state, turning OFF the output voltage (DC link voltage). This disruption will cause a restart of the magnetic bearing electronics.



*When the thermal overload protection is activated, the MBC1400 will remain turned off for several minutes despite AC supply voltage. In order to restart the device, the supply voltage must be turned off for a minimum of 2 minutes. After the device has been turned off, the two fuses in the fuse holder (cf. X9 MAINS on p. 30) must be checked, and replaced if necessary.*

## 11 Accessories

### 11.1 SMX8 sensor amplifier box

For operation with sensor cables that are longer than 10m, the SMX8 sensor amplifier box is usually necessary. The SMX8 box should be placed as close to the sensors; i.e., as close to the machine as possible.

This item is available from MECOS under the following item number:

Designation	Item number	Description
SMX8 sensor amplifier box	BG13161-xxN	For variable sensor cable lengths

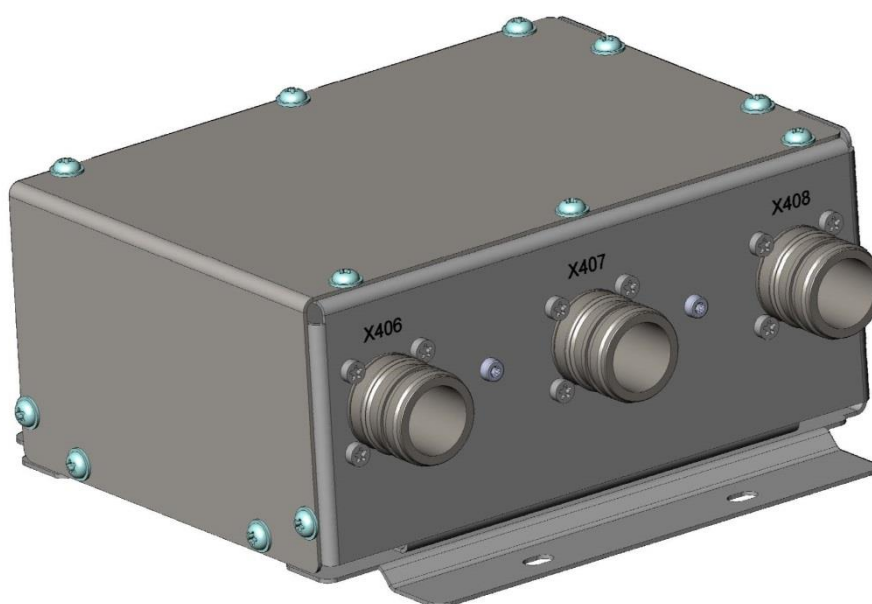

Figure 31: SMX8 sensor amplifier box (Example of variant 01N)

## 11.2 UPS

For ensuring operation during a loss of power, using a UPS is recommended. The UPS must be designed such that it can cover the peak output of the system for the backup period. The MBC1400 has a UPS communications interface that allows the magnetic bearing electronics to monitor and control the UPS.



*MECOS will be happy to support you in evaluating and connecting a UPS that is suitable for your application.*

## 11.3 Toolbox for MECOS magnetic bearing systems

The Toolbox for MECOS magnetic bearing systems (MecosTools) allows modifying a multitude of system parameters, and performing real-time measurements of all processor variables. The Toolbox includes all of the functions for commissioning, validating, and maintaining the magnetic bearing system.

The MecosTools are integrated as Toolbox into the industry-recognized and widely used MATLAB<sup>6</sup> software. This allows using the potential of MATLAB for modelling, controller synthesis, simulation, visualization, and script generation.

There is also an option for generating a client-specific AMB ServiceTool based on the Toolbox for MECOS magnetic bearing systems, which can also be used without MATLAB installed (stand-alone).



*The Toolbox for MECOS magnetic bearing systems and the MECOS AMB ServiceTool can only be used under Windows. Installation requires Admin authorization.*

### NOTICE!

**Due to the varied additional functions of the MecosTools it is generally possible to make modifications to the controller parameter set that may result in instability of the magnetic bearing system. This may result in damage to the system.**

---

<sup>6</sup> MATLAB is commercial software from MATHWORKS INC. for solving mathematical problems and representing the results graphically. Website link: [www.mathworks.com](http://www.mathworks.com)

## 12 Warranty

Unless agreed on otherwise, the Terms & Conditions (AGB) of MECOS AG shall apply.

Any warranty claim shall lapse if the device is opened without authorization, and/or an attempt is made to perform repairs or modifications without consultation with and written confirmation from MECOS AG.

### NOTICE!

**No warranty is assumed for damage caused by incorrect or improper operation, non-compliance with the instructions in this operating manual, use for other than the intended purpose or unauthorized modification, as well as the use of other than original spare parts. In such cases, any and all claims to warranty shall be moot.**

## 13 Applicable documents

The following table includes a list of the applicable documents. As these are generated specifically for each project, they are not included in this instruction manual; however, they are an integral part of the device documentation.

Documents	File name
ML system diagram	BGxxxxx-xxNx_SCH_ML-System_Projecname_Vxx.pdf
Digital I/O configuration parameter report	BGxxxxx-xxNx_RAP-DIG_Projecname_Vxx.pdf
Monitoring parameter report	BGxxxxx-xxNx_RAP-SUP_Projecname_Vxx.pdf
Anybus variable parameter report	BGxxxxx-xxNx_RAP-ANY_Projecname_Vxx.pdf
MBC1400 data sheet	BG13000-xxN_DB-E_MBC1400_Vxx.pdf

Project-specific BG number incl. index:

Project name:





## 15 Glossary

Term	Explanation
AMB	<b>Active Magnetic Bearings</b>
Digital I/O	Parallel client interface on the MBC1400 with insulated digital in- and outputs
Ethernet	Ethernet is a hardwired network technology. It allows data exchange in the form of data packets between all of the devices connected in a local area network (LAN)
FDC	<b>Fast Digital Controller</b> Designation of MECOS processor board
MBC	<b>Magnetic Bearing Controller</b> Designation of a MECOS Magnetic bearing electronics with power amplifier and processor board
ML system	MECOS designation for a magnetic bearing system. Is used for magnetic bearing diagrams and includes MBC, cables, machine incl. bearings and sensors, and if applicable, peripherals.
MPA	<b>Motherboard for Power Amplifier</b> Designation for MECOS amplifier board
PA	<b>Power Amplifier</b> (-channel)
PWM	<b>Pulse Width Modulation</b>
RTC	<b>Real Time Clock</b> Battery-buffered clock in which the current time and date are saved.
SMX8	<b>Sensor Matching BoX 8 Channels</b> Accessory device that amplifies the sensor signals on the machine-side, allowing the use of longer sensor cables
ITB6	<b>Interface Temperature and Bus 6 Channels</b> Expansion card for measuring temperature using the Anybus™ slot



---

MECOS AG  
Hardstrasse 319  
CH-8005 Zürich

Tel.: +41 (0)52 355 52 11  
Fax.: +41 (0)52 355 52 24

[mecos@mecos.com](mailto:mecos@mecos.com)  
[www.mecos.com](http://www.mecos.com)

---

Technische Änderungen vorbehalten / Specifications are subject to change without notification